



User Guide

Gigabit PCI Express Network Adapter
TG-3468

Contents

About This Guide	1
Chapter 1. Get to Know About Your Adapter	2
1.1. Product Overview	3
1.2. LED Status	3
Chapter 2. Connect to a Computer	4
Chapter 3. Install Driver	7
Appendix: Troubleshooting	14

About This Guide

This guide is a complement to Quick Installation Guide. The Quick Installation Guide instructs you on quick installation, and this guide provides the product overview and detailed instructions for each steps.

When using this guide, please notice that features available of the adapter may vary by model and software version. The adapter's availability may also vary by region or ISP. All images, steps, and descriptions in this guide are only examples and may not reflect your actual experience.

Conventions

In this guide, the following conventions are used:

Convention	Description
<u>Teal Underline</u>	Hyperlinks are in teal italic. You can click to redirect to a website or a specific section.
Teal	Contents to be emphasized and texts on the web page are in teal, including the menus, items, buttons, etc.
■ Note:	Ignoring this type of note might result in a malfunction or damage to the device.
👉 Tips:	Indicates important information that helps you make better use of your device.

*Maximum wireless signal rates are the physical rates derived from IEEE Standard 802.11 specifications. Actual wireless data throughput and wireless coverage are not guaranteed and will vary as a result of 1) environmental factors, including building materials, physical objects, and obstacles, 2) network conditions, including local interference, volume and density of traffic, product location, network complexity, and network overhead, and 3) AP limitations, including rated performance, location, connection quality, and AP condition.

More Info

- The latest software can be found at <https://www.tp-link.com/download-center>.
- The Quick Installation Guide (QIG) can be found where you find this guide or inside the package of the product.
- Specifications can be found on the product page at <https://www.tp-link.com>.
- A TP-Link Community is provided for you to discuss our products at <https://community.tp-link.com>.
- Our Technical Support contact information can be found at the [Contact Technical Support](https://www.tp-link.com/support) page at <https://www.tp-link.com/support>.

Chapter 1

Get to Know About Your Adapter

This chapter introduces what the adapter can do and shows its appearance.

This chapter contains the following sections:

- [Product Overview](#)
- [LED Status](#)

1.1. Product Overview

TG-3468 is a high performance adapter designed for the high-speed PCI Express Bus Architecture. Designed to support 10/100/1000Mbps network speed Auto-Negotiation, 802.3x flow control and Wake-on-LAN technology. TG-3468 is a highly integrated and cost-effective gigabit Ethernet adapter which is a good selection to upgrade your network.

- Integrated 10/100/1000Mbps transceiver
- Fully compliant with IEEE 802.3, IEEE 802.3u, IEEE802.3ab
- Auto-Negotiation with Next Page capability
- Wake-on-LAN and remote wake-up support
- Support Full Duplex flow control (IEEE802.3X)
- Support IEEE 802.1p Layer 2 Priority Encoding and IEEE802.1Q VLAN tagging

1.2. LED Status

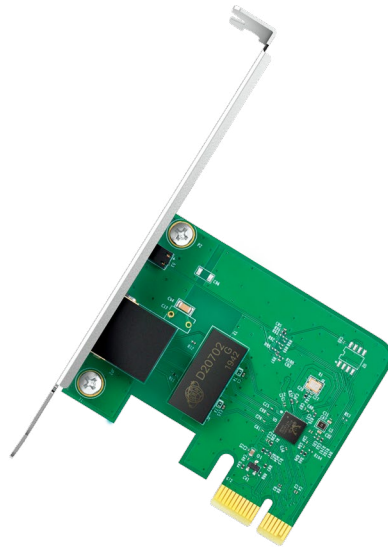

LED Status:

Status	Indication
Off	The driver has not been installed or the cable is not connected.
Solid On	The driver has been installed and the connection is built.

◆ Tips:

If the LED is off, try these troubleshooting tips:

1. Check if the adapter is recognized and enabled or not. Refer to [Troubleshooting-T3](#) for detailed instructions.
2. Remove and reinsert the adapter.
3. Reinstall the adapter software, if necessary.

Chapter 2

Connect to a Computer

This chapter introduces how to connect the adapter to your computer.

Before you begin using your adapter, insert the adapter into your computer by following these steps.

1. Turn off the computer, unplug the power cable and remove the case panel.

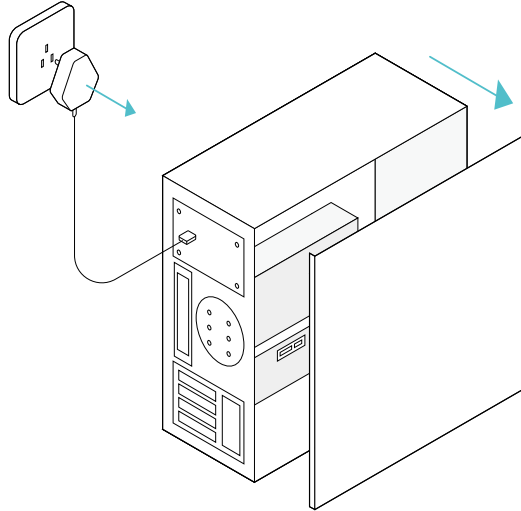

2. Locate an available PCI-E slot and carefully insert the adapter.

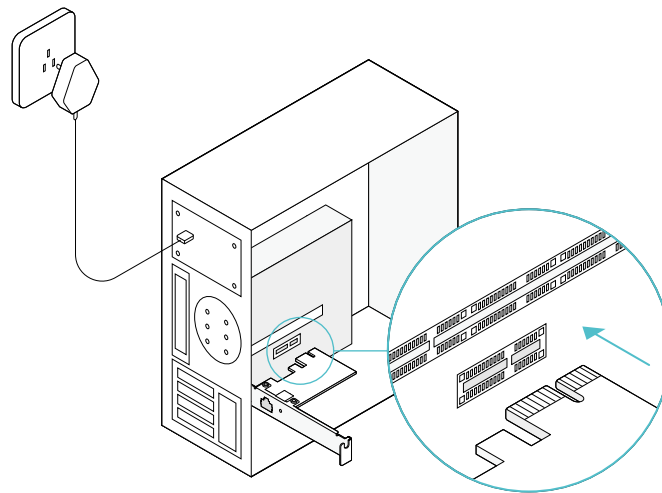

Note:

If the bracket is not suitable for your computer, detach it from the adapter's board and replace it with the low-profile bracket provided.

3. Replace the case panel, plug in the power cable and turn on your computer. Then connect the Ethernet cable to the adapter.

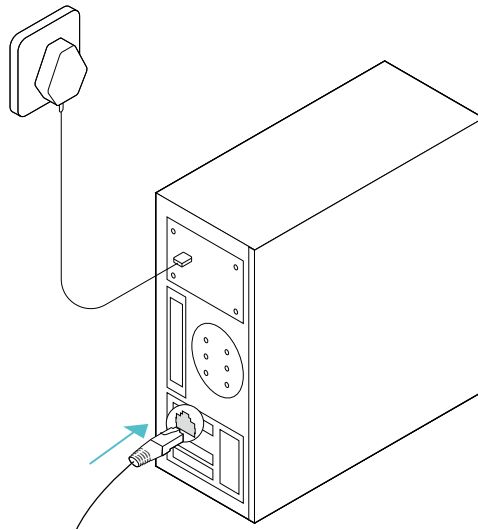

Chapter 3

Install Driver

This chapter introduces how to install your adapter's driver in different Windows systems, including Windows 7/8/8.1/10.

This section will guide you through the installation for different Windows systems, including Windows 7/8/8.1/10.

◆ Tip: For Windows 10, you can enjoy using it directly. If not, install the driver manually.

1. Insert the CD into the CD-ROM drive.
2. Right-click **Computer**, and then click **Manage**.

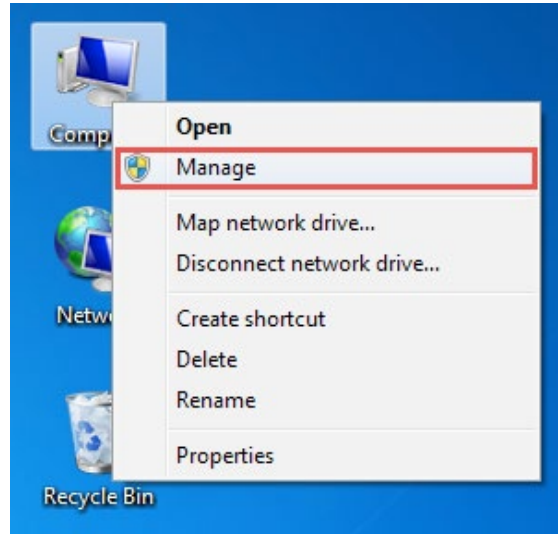

3. Open **Device Manager**. Go to **Network adapters**, right-click **Realtek PCIe GBE Family Controller**, and click **Update driver...**

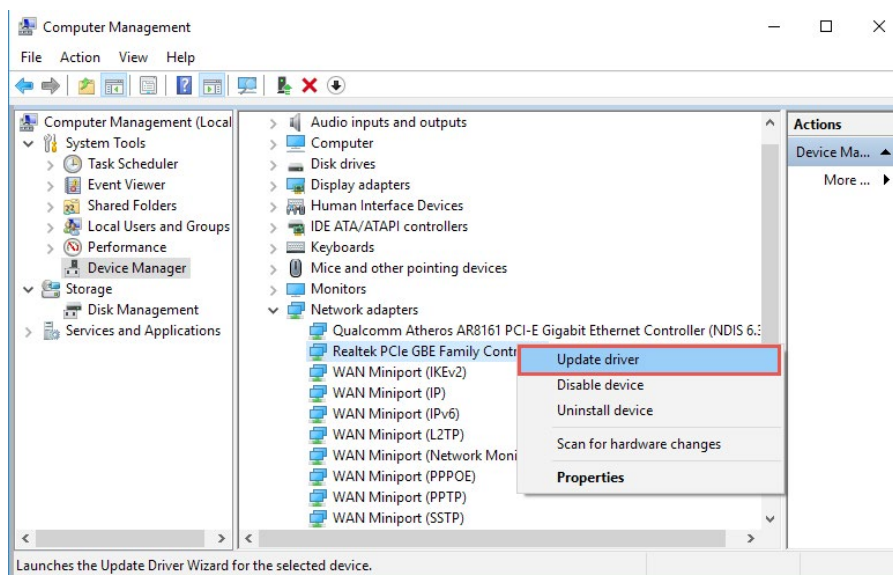

OR

Open **Device Manager**. Go to **Other Devices** and right-click **Ethernet Controller**; then click **Update Driver Software...**

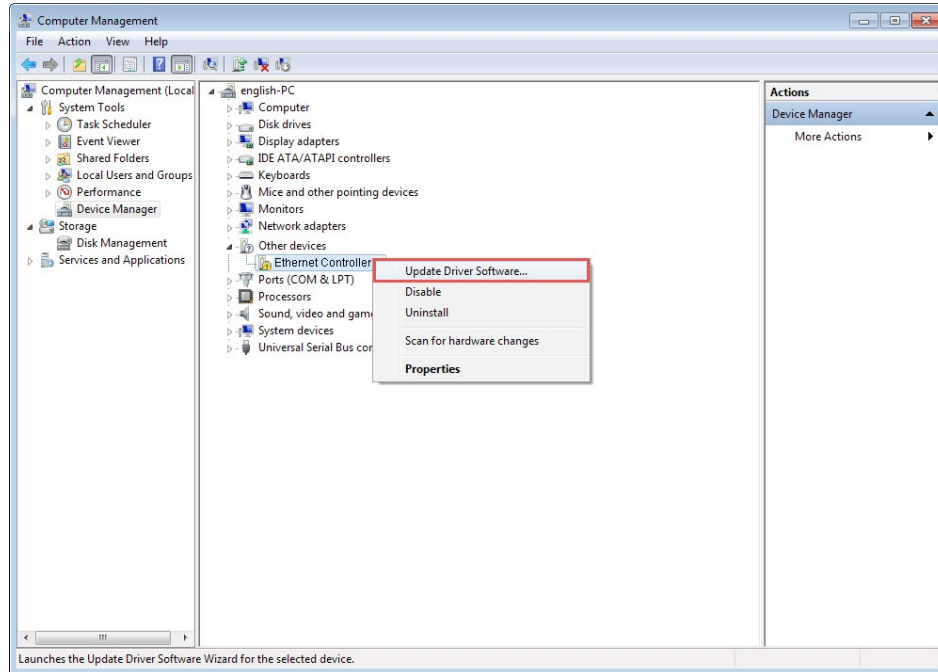

4. Select **Browse my computer for driver software**.

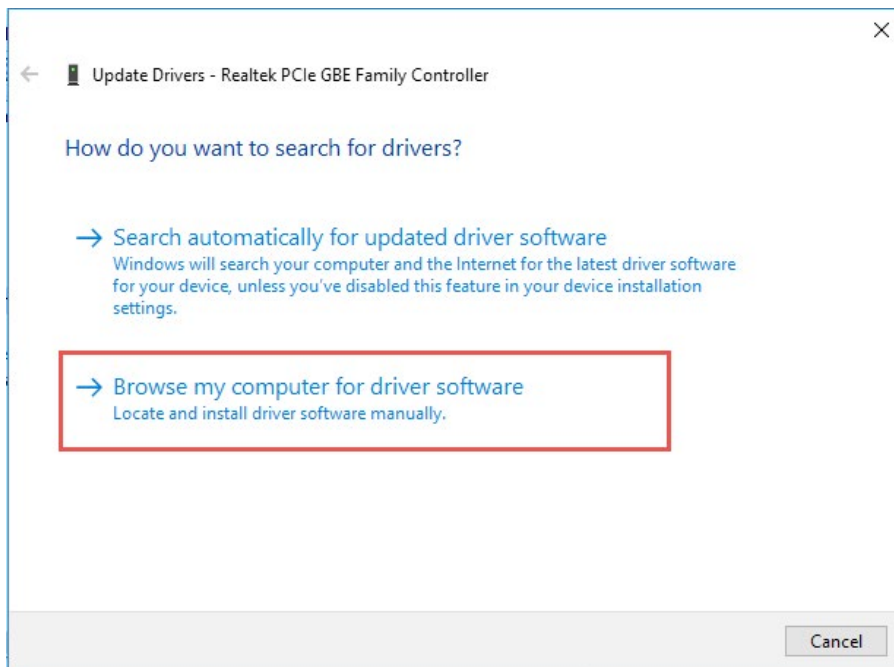

5. Select [Let me pick from a list of device drivers on my computer](#).

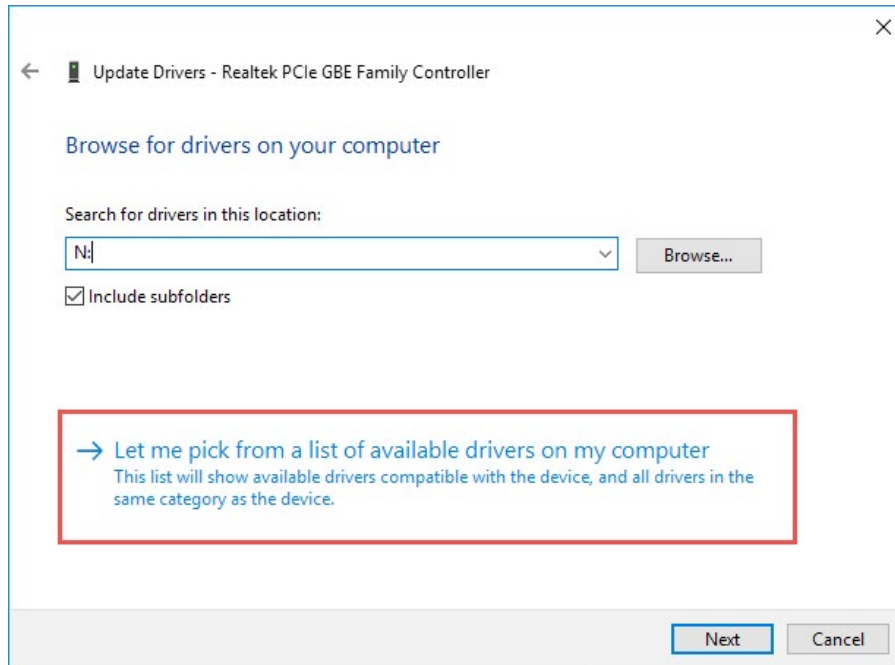

6. For [Windows 7](#): Choose [Show All Devices](#), and then click [Next](#).

7. Click [Have Disk...](#)

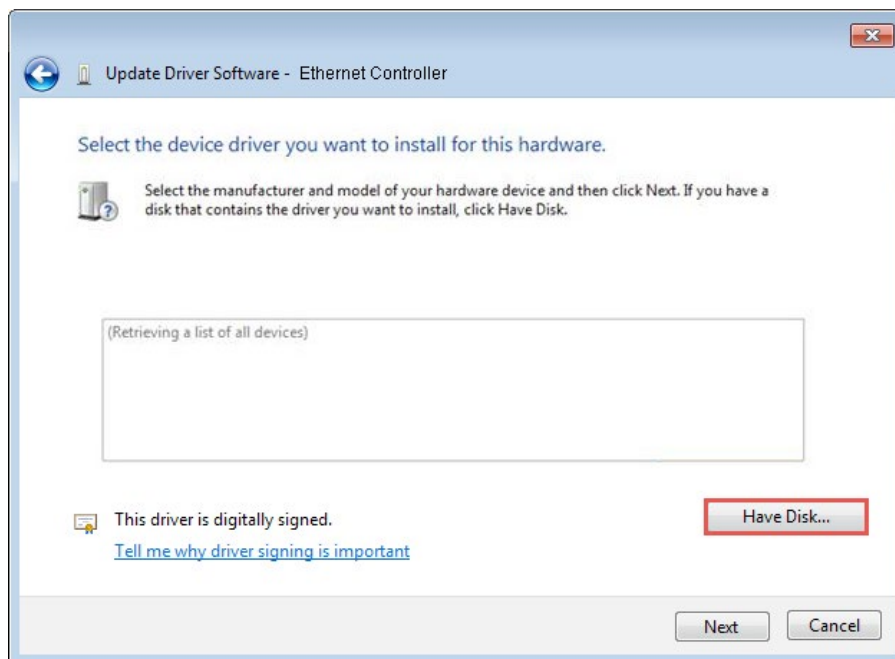

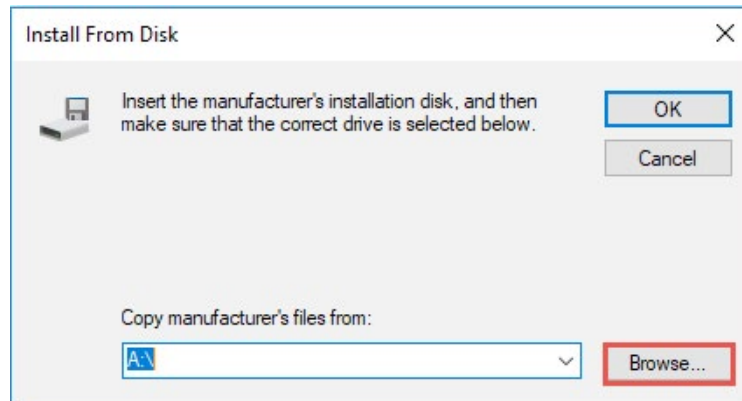
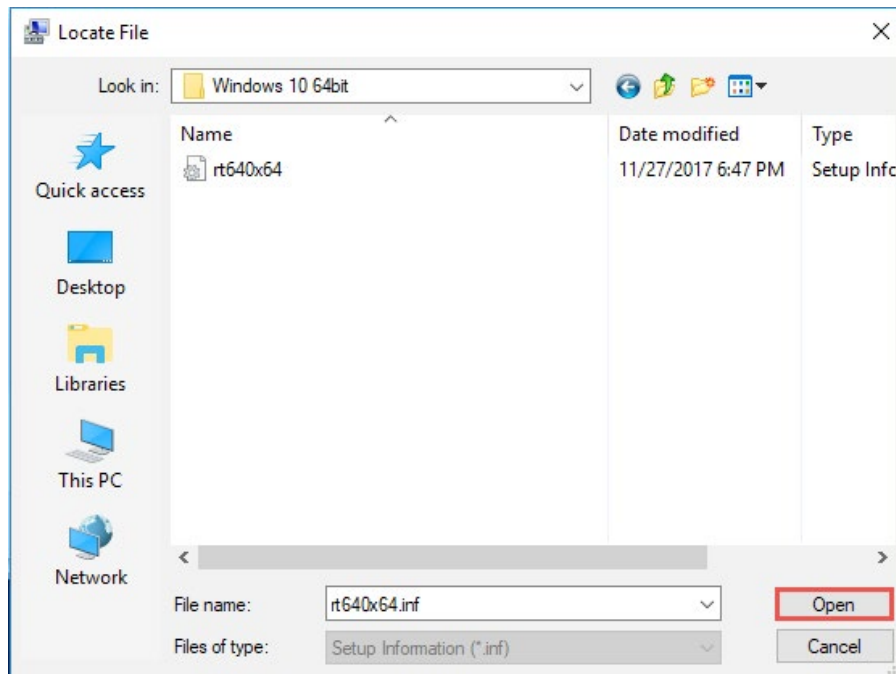
8. Click **Browse...**9. Go to **Computer > CDXXX > TG-3468** and choose the **.inf** file based on your Windows system.

10. Click **OK**.

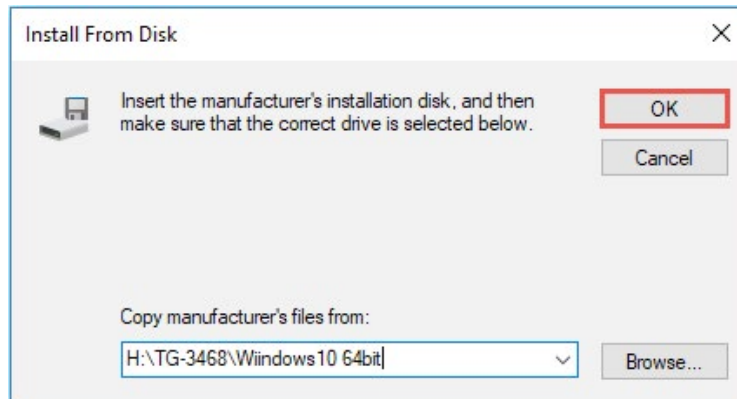

11. Select **Realtek PCIe GbE Family Controller**, and click **Next**.

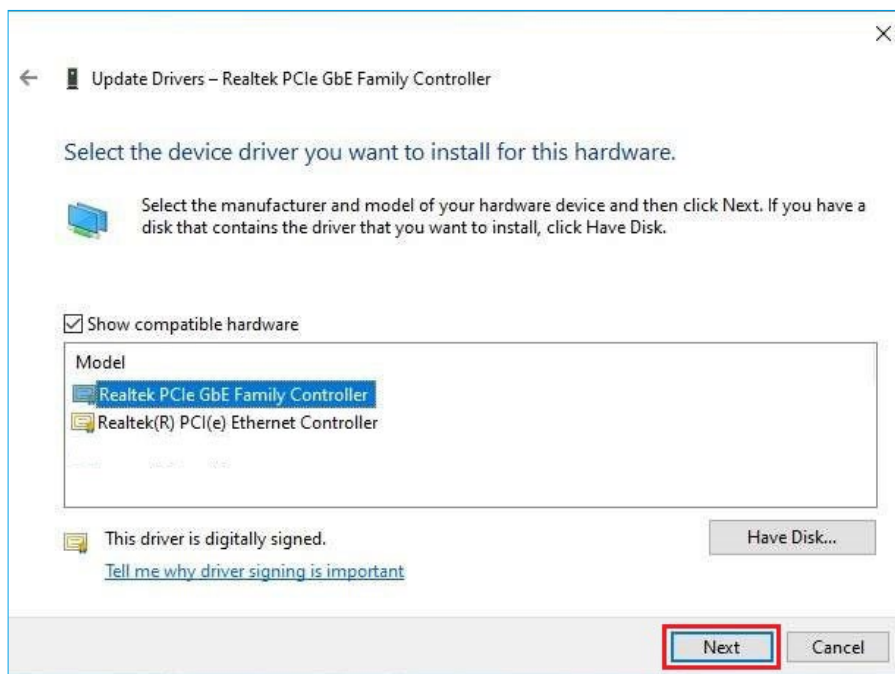

12. Click **Close** when the driver is installed successfully. And then restart your computer to finish the installation.

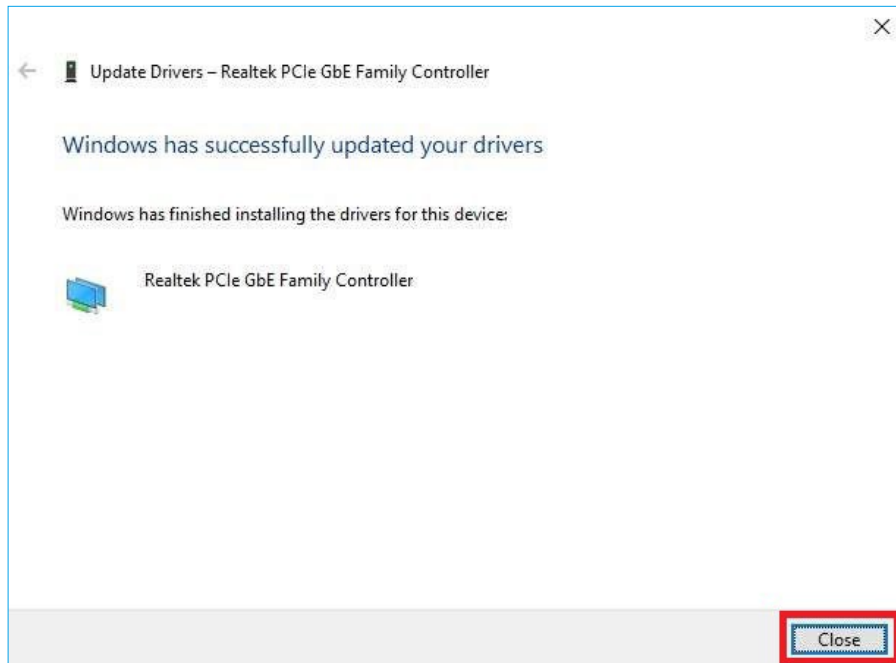

Appendix: Troubleshooting

T1. What should I do if the adapter is not detected?

- You could find and download the driver at <https://www.tp-link.com/download-center>

T2. How to find the hardware version of the adapter?

- The hardware version is printed on the product label on the package or the adapter. There is a character string "Ver:X.Y" (for example, Ver:2.0) in the Serial Number field, and the number X is the hardware version of the adapter.



- Visit <https://www.tp-link.com/faq-46.html> and follow the second method to find the hardware version of the adapter.

T3. What should I do if PC cannot find the new hardware?

- Restart your computer and try again.
- Check if the network adapter is inserted in the PCI Express slot properly.
- Reinsert the adapter or try to change another PCI Express slot.
- Try inserting the adapter on a different computer.
- Make sure you meet the minimum system requirements for the adapter and that the latest Windows and system updates are installed on your computer.
- If the problem persists, contact our Technical Support.

T4. How to check if I have installed the driver for my adapter successfully or not?

1. On your computer, please right click the Computer icon and go to [Manage](#);

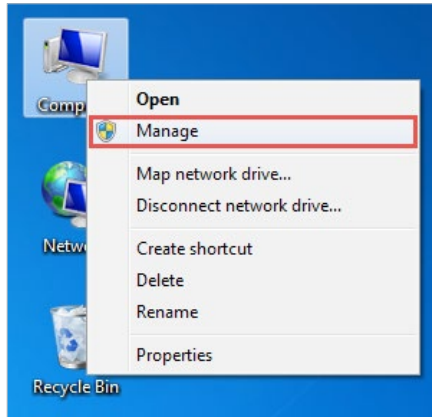

2. Open the [Device Manager](#) and go to [Network adapters](#), and then find the corresponding TP-Link adapter, right click it and then go to [Properties](#);

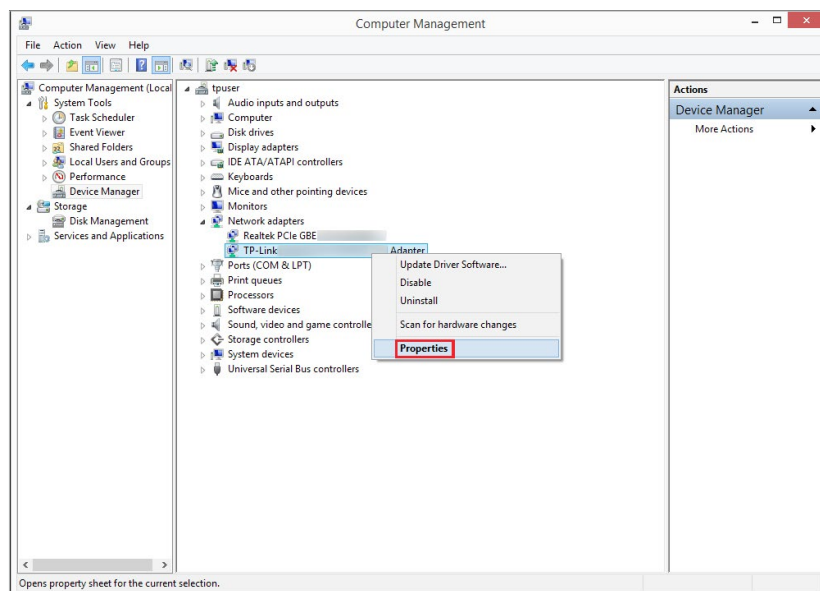

3. If you can see "This device is working properly." in the red box, you have already installed the driver successfully.

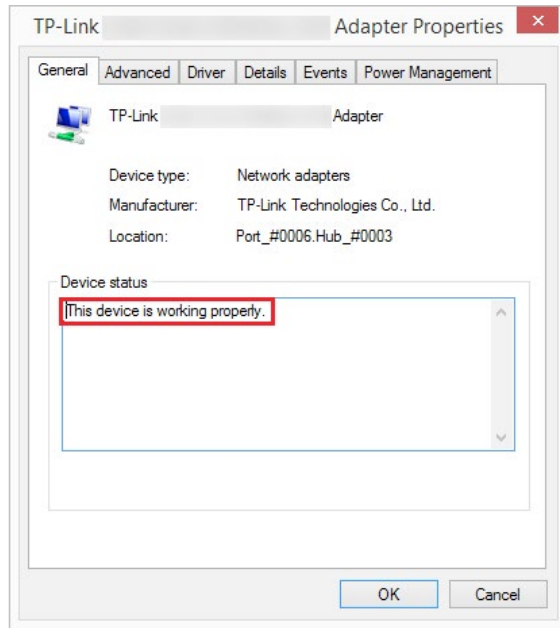

FCC compliance information statement



Product Name: Gigabit PCI Express Network Adapter

Model Number: TG-3468

Responsible party:

TP-Link USA Corporation, d/b/a TP-Link North America, Inc.

Address: 145 South State College Blvd. Suite 400, Brea, CA 92821

Website: <https://www.tp-link.com/us/>

Tel: +1 626 333 0234

Fax: +1 909 527 6803

E-mail: sales.usa@tp-link.com

This equipment has been tested and found to comply with the limits for a Class B digital device, pursuant to part 15 of the FCC Rules. These limits are designed to provide reasonable protection against harmful interference in a residential installation. This equipment generates, uses and can radiate radio frequency energy and, if not installed and used in accordance with the instructions, may cause harmful interference to radio communications. However, there is no guarantee that interference will not occur in a particular installation. If this equipment does cause harmful interference to radio or television reception, which can be determined by turning the equipment off and on, the user is encouraged to try to correct the interference by one or more of the following measures:

- Reorient or relocate the receiving antenna.
- Increase the separation between the equipment and receiver.
- Connect the equipment into an outlet on a circuit different from that to which the receiver is connected.
- Consult the dealer or an experienced radio/ TV technician for help.

This device complies with part 15 of the FCC Rules. Operation is subject to the following two conditions:

- 1) This device may not cause harmful interference.
- 2) This device must accept any interference received, including interference that may cause undesired operation.

Any changes or modifications not expressly approved by the party responsible for compliance could void the user's authority to operate the equipment.

We, **TP-Link USA Corporation**, has determined that the equipment shown as above has been shown to comply with the applicable technical standards, FCC part 15. There is no unauthorized change is made in the equipment and the equipment is properly maintained and operated.

Issue Date: 2020.03.30

CE Mark Warning



This is a class B product. In a domestic environment, this product may cause radio interference, in which case the user may be required to take adequate measures.

EU declaration of conformity

TP-Link hereby declares that the device is in compliance with the essential requirements and other relevant provisions of directives 2014/30/EU, 2014/35/EU, 2011/65/EU and (EU)2015/863.

The original EU declaration of conformity may be found at <https://www.tp-link.com/en/ce>

Canadian Compliance Statement

This device contains licence-exempt transmitter(s)/receiver(s) that comply with Innovation, Science and Economic Development Canada's licence-exempt RSS(s). Operation is subject to the following two conditions:

- (1) This device may not cause interference.
- (2) This device must accept any interference, including interference that may cause undesired operation of the device.

L'émetteur/récepteur exempt de licence contenu dans le présent appareil est conforme aux CNR d'Innovation, Sciences et Développement économique Canada applicables aux appareils radio exempts de licence. L'exploitation est autorisée aux deux conditions suivantes :

- 1) L'appareil ne doit pas produire de brouillage;
- 2) L'appareil doit accepter tout brouillage radioélectrique subi, même si le brouillage est susceptible d'en compromettre le fonctionnement.

Industry Canada Statement

CAN ICES-3 (B)/NMB-3(B)

BSMI Notice

安全諮詢及注意事項

- 請使用原裝電源供應器或只能按照本產品注明的電源類型使用本產品。
- 清潔本產品之前請先拔掉電源線。請勿使用液體、噴霧清潔劑或濕布進行清潔。
- 注意防潮，請勿將水或其他液體潑灑到本產品上。

- 插槽與開口供通風使用，以確保本產品的操作可靠並防止過熱，請勿堵塞或覆蓋開口。
- 請勿將本產品置放於靠近熱源的地方。除非有正常的通風，否則不可放在密閉位置中。
- 不要私自拆開機殼或自行維修，如產品有故障請與原廠或代理商聯繫。

限用物質含有情況標示聲明書

產品元件名稱	限用物質及其化學符號					
	鉛 Pb	鎘 Cd	汞 Hg	六價鉻 CrVI	多溴聯苯 PBB	多溴二苯醚 PBDE
PCB	○	○	○	○	○	○
備考 1. "超出 0.1wt %" 及 "超出 0.01wt %" 系指限用物質之百分比含量超出百分比含量基準值。						
備考 2. "○" 系指該項限用物質之百分比含量未超出百分比含量基準值。						



Продукт сертифіковано згідно с правилами системи УкрСЕПРО на відповідність вимогам нормативних документів та вимогам, що передбачені чинними законодавчими актами України.



Safety Information

- Keep the device away from water, fire, humidity or hot environments.
- Do not attempt to disassemble, repair, or modify the device.

Please read and follow the above safety information when operating the device. We cannot guarantee that no accidents or damage will occur due to improper use of the device. Please use this product with care and operate at your own risk.

Explanation of the symbols on the product label

Symbol	Explanation
	<p data-bbox="363 331 539 363">RECYCLING</p> <p data-bbox="363 390 1369 548">This product bears the selective sorting symbol for Waste electrical and electronic equipment (WEEE). This means that this product must be handled pursuant to European directive 2012/19/EU in order to be recycled or dismantled to minimize its impact on the environment.</p> <p data-bbox="363 569 1369 686">User has the choice to give his product to a competent recycling organization or to the retailer when he buys a new electrical or electronic equipment.</p>